

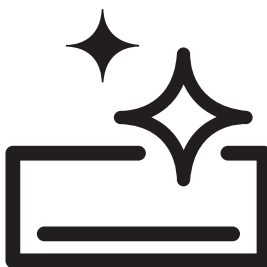

Air Conditioner

Owners Manual



fi !/Ł mfi//Ł mfiŁ/Ł mfiž/Ł mfiV fVŁ



Please read this guide first!

Dear Customer,

We'd like you to achieve the optimal efficiency from our product, which has been manufactured in modern facilities with meticulous quality controls.





For this purpose, please fully read the user guide before using the product and keep the guide as a reference source. If you turn the product over to another person, provide this guide along with the product.

User guide ensure the quick and safe use of the product.

- Please read the user guide before installing and operating the product.
- Always observe the applicable safety instructions.
- Keep the user guide within easy reach for future use.
- Please read any other documents provided with the product.
Keep in mind that this user guide may apply to several product models.
The guide clearly indicates any variations of different models.
- This product is an air conditioner designed for heating and cooling purposes.

Symbols and Remarks

The following symbols are used in the user guide:

-  Important information or useful usage tips.
-  Warning against health and property risks.
-  Warning against electric shock.
-  Warning against flammable material.



This product was manufactured in environmentally friendly facilities without any harmful impact on the environment.

Complies WEEE Regulations.



CONTENT

1 The A/C 4

Overview	4
Indoor Unit	4
Operation status indicator display	4
Outdoor Unit	5
Wireless remote controller	6
Specifications	7

2 Important safety instructions 8

General safety	8
Batteries	9
Intended use	9
Child safety	10
Compliance with WEEE regulations and waste disposal	10
Disposing of the package	10
Practical and useful tips	10

3 Installation 11

Right place for installation	12
Power connection	12
First use	12
Transportation of the product	12

4 Preparation 13

What to do for energy saving	13
Inserting the batteries	14
Operation method	14
Points to take into consideration when using your remote control	14

5 Operating the product 15

Turning the A/C on.	15
Operating modes	15
Mode selection	15
Cooling the room	15
Rapid cooling function	15
Heating the room	16
Rapid heating function	16
Auto-operation mode	17
Dehumidifying mode	17
Fan mode	17
Fan speed adjustment	18
Temperature adjustment / Room temperature control	18
Directing the horizontal air flow.....	19
One-touch soft air	19
Information display	19
Display on/off	19

Auto clean function	20
Economy	20
Silent function	21
Setting the clock	21
Sleep mode function	22
Timer On/Off function	22
Timer-On.....	22
Timer-Off.....	23
Automatic start	24
Cancel automatic restart	24
Operating the A/C with the remote control	24
Test operation mode	24

6 Maintenance and cleaning 25

Cleaning the air filter	26
Cleaning the 3M filter	26

7 Troubleshooting 27

8 Consumer services 28

Customer Satisfaction Policy	28
------------------------------------	----

1 Your A/C

Overview Indoor Unit

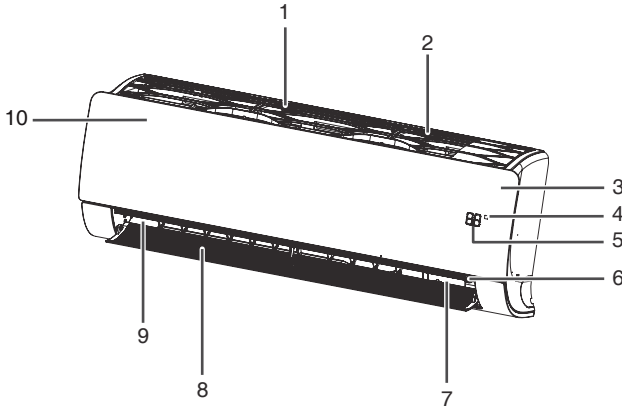

- 1- Air Intake
- 2- Air filter
- 3- Front panel
- 4- Signal receiver
- 5- Hidden indicator
- 6- Manual operation button
- 7- Ionizer
- 8- Air Deflector (Horizontal Vane)
- 9- Air Outlet
- 10- 3M filter

Operation status indicator display

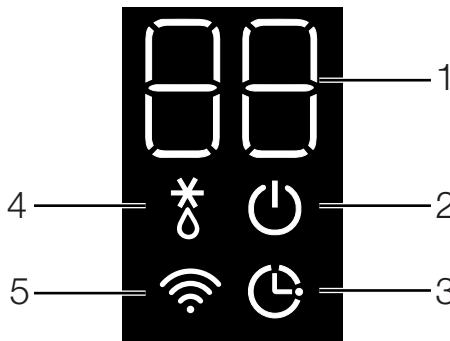

- 1- Digital Display
- 2- On/Off Button
- 3- Timer
- 4- Defrosting & Preheating
- 5- Wireless

Outdoor unit

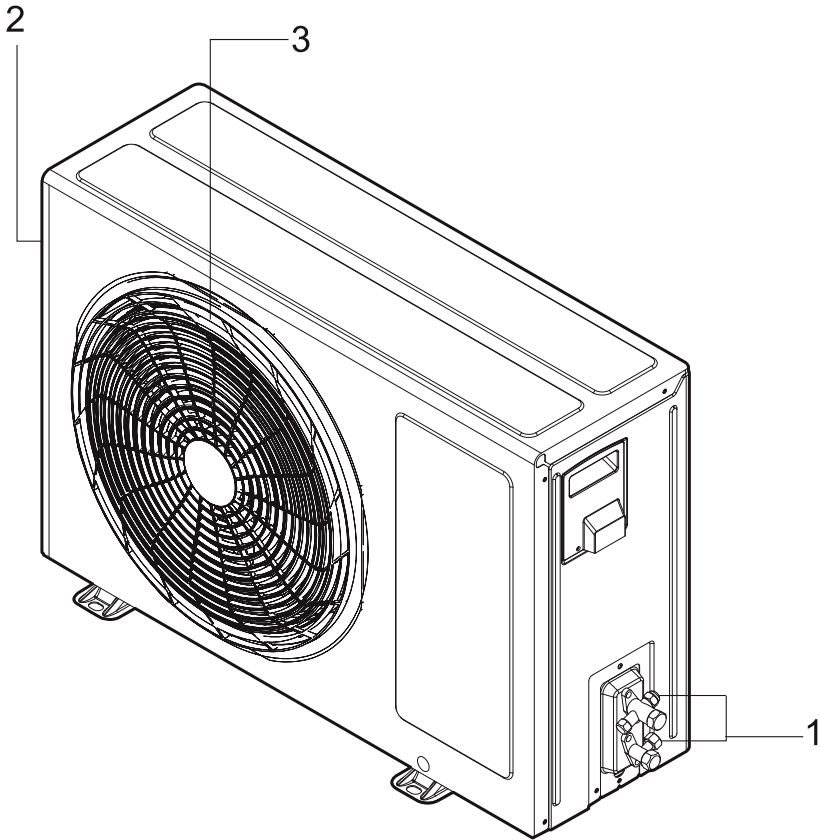

- 1- Indoor-Outdoor Unit Piping Connection Valves
- 2- Air Intake Vent
- 3- Air Outlet Vent

Wireless remote controller

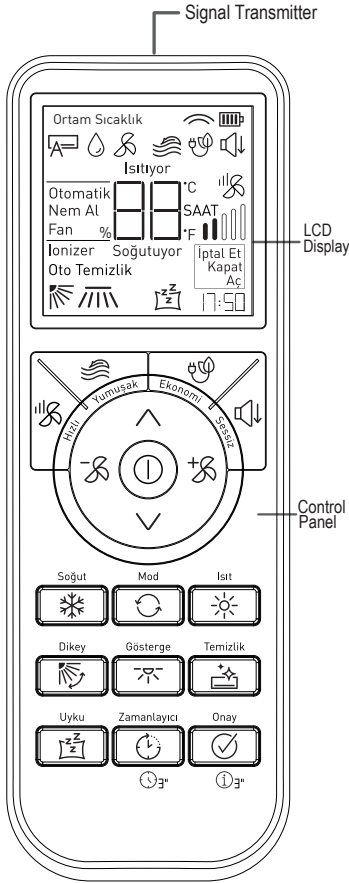

Control Panel	Display Screen	Description
		Rapid Cooling/Heating Function: Increases/Decreases the indoor temperature in a short time.
		Soft Air: Directs the direct incoming air flow up or down.
		Energy Control Cooling Function: Activates the energy-saving mode. This mode consists of three steps.
		Silent function: Decreases the outdoor unit volume.
		Indoor Fan Speed Adjustment: It adjusts the fan speed.
		Temperature Adjustment: Regulates the room temperature during cooling and heating. Fahrenheit ↔ Celsius Celsius Switch: Pressing the "Sleep" and "Timer" buttons at the same time for 10 seconds will enable the switch.
	—	On/Off: Switches On/Off the A/C.
	Soğutuyor	Cooling Mode: Cools the environment.
	Mod / Otomatik / Nem Al / Fan	Auto-operation Mode: Heats or cools according to the set temperature. Dehumidifying mode: Removes the humidity in the environment. Fan Mode: Provides air circulation in the environment.
	Isıtıyor	Heating Mode: Heats the environment.
		Air flow direction: Sets the air flow direction vertically.
	—	Switches the display on the air conditioner on/off
	Oto Temizlik	Cleaning: Removes moisture that occurs in the indoor unit.
		Sleep Function: Prevents your room from cooling down or warming up extremely during sleep.
	Aç	Timer On: Turns on the air conditioner at the settime.
	Kapat	Timer Off: Turns off the air conditioner at the set time.
	İptal Et	Timer Cancel: Cancels all time settings.
	—	Confirms the settings for the timer and clock.
		Enters the clock setting section of the controller when the "Timer" button (🕒) is pressed and held for 3 seconds.
	Ortam Sıcaklık	Ambient Temperature is displayed on the controller display when the "Confirm" button (✅) is pressed and held for 3 seconds.

i As the control temperature sensor detects temperatures in a wide range, the ambient temperature displayed on the controller can be misleading.

Specifications

SPECIFICATIONS			09325	12325	15325	18325	24325
Capacity	Ö [l] *	Btu/h	9000	12000	14500	18000	24000
	P^ææ *	W	2638	3517	4250	5275	7034
Power consumption	Ö [l] *	Btu/h	11260	13648	15013	19790	25590
	P^ææ *	W	3300	4000	4400	5800	7500
EER/COP*	Ö [l] *	W/W	3,8 / 4,1	3,2 / 3,8	3,2 / 3,9	3,2 / 3,6	3,05 / 3,35
	P^ææ *	W/W	7,0 / 4,0	6,6 / 4,0	6,4 / 4,0	7,0 / 4,3	6,9 / 4,3
Seasonal Efficiency Rating	Ö [l] *	-	A++	A++	A++	A++	A++
	P^ææ *	-	A+	A+	A+	A+	A+
Design Load	Ö [l] *	W	2500	3500	4200	5000	6600
	P^ææ *	W	2500	2500	2500	3900	5000
Annual Energy Consumption	Ö [l] *	kWh/year	125	186	230	250	335
	P^ææ *	kWh/year	875	875	875	1270	1628
Dehumidification Capacity		lt/h	1,1	1,3	1,6	1,8	2,5
Power Supply		V/Ø/Hz	220-240 / 1 / 50	220-240 / 1 / 50	220-240 / 1 / 50	220-240 / 1 / 50	220-240 / 1 / 50
Running Current (Nom/Max)	Ö [l] *	A	3,5 / 6,0	4,7 / 6,0	5,8 / 7,0	7,3 / 9,0	10,8 / 14,0
	P^ææ *	A	4,0 / 7,0	4,7 / 7,0	5,0 / 7,0	7,1 / 9,5	10,0 / 14,0
C-Type Automatic Fuse		A	16	16	16	20	25
Sound Pressure (Sleep)	Ö [l] *	dBA	19	19	19	31	31
Sound Power	Ö [l] *	dBA	59	59	60	60	65
	P^ææ *	dBA	65	65	65	65	70
Net Weight	Ö [l] *	kg	8,5	8,5	8,5	11,7	11,7
	P^ææ *	kg	28	28	33,6	37	46
Ö [l] *				U			
P^ææ *				U [l] *			

- i** In order to increase the product quality, the technical specifications may be changed without prior notice.
- i** Figures in this manual are schematic and may not exactly match the product.
- i** The values provided with the appliance or its accompanying documents are laboratory readings in accordance with the respective standards. These values may differ depending on the use and ambient conditions.

* EER and COP values are energy efficiency ratios and are calculated according to TS EN 14511 measurement standards.

Cooling: Indoor Temperature 27°C DB, 19°C WB / Outdoor: 35°C DB, 24°C WB

Heating: Indoor Temperature 20°C DB, 15°C WB / Outdoor: 7°C DB, 6°C WB

**SEER and SCOP values are seasonal energy efficiency ratios and are calculated according to TS EN 14825 measurement standards.

- i** Catalogue data are energy consumption values provided as per standard test result. Actual energy consumption may vary as per the conditions that the appliances are used.

- i** DB: Dry bulb temperature, WB: Wet bulb temperature

2 Important safety instructions

This section includes the safety instructions necessary to prevent the risk of personal injury or material damage. Failure to observe these instructions shall void any and all warranties.

General safety

- Avoid exposure to the air flow on your body for a long period of time.
- Set the product to the best temperature as per the ambient conditions and the health conditions.
- Do not drink water drained from the appliance. Otherwise, you may face serious health problems.
- Do not operate the product in non-ventilated areas for a long period of time.
- Ventilate the environment while operating the product together with other appliances such as stoves, etc.
- Wait for 3 minutes to operate the product after turning it off. The fuse in your installation may blow.
- Do not operate your product for a long time if the humidity is too high or if a door or a window is open.
- Plug the product in a grounded electrical installation protected by a fuse conforming to the values specified in the “Technical Specifications” chart. Always have an authorized electrician install the grounding equipment for operation either with or without transformer. Our company shall not be responsible for the damages that shall be incurred due to using the product without grounding according to local regulations.
- Make sure that the mains voltage is proper for the product.
- Use a delayed-type (C-type) automatic fuse according to the product model.
- Do not damage the cooling circuit where refrigerant circulates through the product, using cutting or piercing tools. The refrigerant gas that may spray out in case of puncturing in the gas channels of the heat exchanger, upper surface coatings on pipe extensions may cause skin irritation and eye injuries.
- Do not cover or block the air inlet-outlet vents and outdoor unit with any object while the product is operating.
- Do not spray flammable or cooling gases directly to the product.
- Do not insert your hand or any other object into the air inlet-outlet vents on the indoor and outdoor units while the product is operating. Internal fans can cause serious injuries.
- Do not open up the front panel while it is being operated. Do not touch the Neo Plasma filter, if present in the product.
- If the product leaks refrigerant, open the windows to ventilate the room and call the Authorized Service.
- Shut off the gas flow and turn off the A/C in case of a flammable gas leak in the environment of the product. Do not operate the A/C again without ventilating the environment properly.
- Do not place heating devices near the product and the power cable. Excessive heat from these devices can cause melting of the plastic parts of the product.
- De-energise using the automatic fuse during power outages or in the event of a storm. Failure to comply with this instruction may cause fire or electrocution.
- Make sure that the power cable or its plug (if any) is not detached or broken. Failure to comply with this instruction may cause electric shock or damage to the product.
- Do not touch, operate, repair the A/C with wet hands. Failure to comply with this instruction may cause electric shock or damage to the product.
- If power cord is damaged, do not operate the product. Contact the authorized service.
- Do not pull and strain the power cord of the product. Any damage to the cord may cause an electric shock.



The flammable R32 type refrigerant is used in the device. There is a risk of fire if refrigerant leaks and is exposed to an external source of ignition.

- Keep the power cable away from heat sources .
- Do not place any objects on the power cable
- If the product shall not be used for a long time, disconnect it from power from the fuse.
- Contact the Authorized Service if the product gets wet in any way.
- Avoid contact of the electrical components with water. If case of contact of the electrical components of the product with water, switch off the product and call the Authorized Service.
- If case of a strange sound, smoke or smell coming from the product, turn off the product from the fuse box and call the Authorized Service.
- During installation, maintenance, cleaning and repair work, make sure that the power is cut off from the fuse.
- Installation and repair should always be performed by Authorized Service. Manufacturer shall not be held responsible for damages caused by operations performed by unauthorized persons.
- Do not expose people, animals or plants to hot or cold air blown by the A/C.
- Make sure that only the parts specified in the service parts list are used. Do not modify the device. Failure to do so may result in death, serious injuries or damage to the product.
- If the A/C is left under water in cases like flood, contact the authorized service. Failure to do so may cause explosions or fire.
- Do not place any items on the A/C. This may cause failure of the product. For interior cleaning of the product, contact an authorized service or the dealer from whom you have purchased the product. Detergents shall not be used as they cause corrosion and damage to the surface.
- There shall be no obstructions in front of all essential ventilation openings.

Batteries

- Do not expose batteries to direct sunlight, fire, etc. factors or excessive heat.
- Do not use old and new batteries together.
- Replace the depleted batteries only with batteries of the same model, value and specification. Do not use rechargeable batteries.
- Dispose the depleted batteries in accordance with local laws and regulations. In this way, you contribute to the prevention of potential damages to the environment and human health.
- Do not use the remote control if the batteries have leaked. If leaked liquid gets on your skin or clothing, wash with plenty of clean water.
- Do not swallow any liquid leaking from the batteries. If swallowed, contact the nearest health institution.

Intended Use

- This product is intended for interior operation.
- The product's service life is 10 years. This is the period for which the spare parts required for the operation of this product as defined is provided by the manufacturer.
- This product is not intended to be used by people with physical, sensory and mental disabilities (including children) or those who have not adequate experience and knowledge regarding its use, unless they are under the supervision of a person responsible for their safety or who shall provide the instructions required for the operation of the product.
- Do not use the product for purposes other than cooling your environment (e.g. protection of delicate devices, food, pets, plants and art works). This product is not special cooling system, it is a consumer-type A/C. Such operations may damage these items.

Child safety

- Electrical products are dangerous for children. Keep children away from the product while it is operated and do not let them to play with the product.
- Pay attention to temperature levels of the rooms where small children and elderly persons are present.
- The packaging materials are dangerous for children. Keep packaging materials away from children.
- Make sure that children do not climb on the air conditioner's outdoor unit and hit it. This can lead to death or damage to the product.

Compliance with AEEE regulations and Waste Disposal

i Disposal of refrigerant and oil and disassembly of other parts shall be performed as per the relevant local and national legislation.

i Do not disassemble the system on your own. Disassembly of the systems and other operations with the refrigerant, oil and components shall be performed by the authorized service as per the relevant local and national legislation.



This product does not contain the dangerous and prohibited materials indicated in "Waste Electrical and Electronic Equipment Control Regulation" published by Ministry of Environment and Urbanisation of

Republic of Turkey. Complies WEEE Regulations. This product was manufactured from recyclable and reusable high quality parts and materials. Therefore, do not dispose of this product with other domestic wastes at the end of its service life. Take it to a collection point for electrical and electronic equipment. You can ask your local administration about these collection points. You can help protect the environment and natural resources by delivering the used products for recycling. Before disposing of the product, cut off the plug from the cord for the safety of the children.

Disposing of the package

The package of the product is made of recyclable materials. Dispose it of by classifying as per the waste instructions. Do not dispose it of with normal domestic waste.

Practical and useful tips

- Do not cool your room excessively. This is not good for your health, and it causes excessive power consumption.
- Prevent direct sunlight to the room while the A/C is operated, keep curtains and blinds closed.
- Adjust the orientation of the product's vertical and horizontal air deflector so that the room temperature and airflow are homogeneously distributed throughout the room.
- Use of air curtains in large rooms where doors are kept open continuously such as cafeterias and confectioneries shall reduce the power consumption and shall allow you to achieve better efficiency while using the product. In such a case, the environment reaches the desired temperature more quickly.
- Keep doors and windows closed as much as possible to keep cool and warm air in the room.
- Clean the washable dust filter regularly at the start and end of the season. Clogging in the washable dust filter reduces airflow, cooling and dehumidification performances. If the washable dust filter is not cleaned regularly, the cooling-heating capacity will be reduced and some of the electricity used will be wasted.
- As the windows are kept closed during the operation of the product, ventilate the room by opening windows at regular intervals.
- If the product will not be operated for a long time, run it in fan mode for 2-3 hours, this will remove the moisture inside your product. Shut it off from the fuse.
- Since the air conditioner will dry the air in the room while it is operating in heating mode, products that humidify the ambient air can be used in combination with the air conditioner.

3 Installation

Please contact the nearest Authorized Service for the installation of the product. Check if the electrical installation and water drain is proper before calling the authorized service to have the product ready for operation. If not, call an electrician and plumber to arrange the utilities as necessary.

- i** Installation shall be performed as per the local standards and you shall follow the National Electrical NFPA 70/ANSI C1- -1003 standard if no local standard is available.
- i** It is customer's responsibility to prepare the location the product shall be placed on and also have power and waste water installation prepared.
- i** Cable connection between indoor and outdoor unit shall be rendered safe and secure and it shall follow a suitable route that it shall not be pulled away from cable terminal blocks by any load. Improper connection may cause generation of heat or fire.
- i** Install the panel and cover of the control box securely.
- i** Do not place the product in the vicinity of areas with explosion or fire risk. Failure to do so may cause explosions or fire.
- i** Do not mix any gas or air into the system other than the refrigerant used in the system. If air enters the refrigerant system, it can cause very high pressures, which can result in personal injuries or equipment malfunction.
- i** Use packed materials such as screws, nails or batteries carefully after installation or repair. Otherwise, these may cause serious injuries.
- i** Attach the condensation drain hose so that it can easily drain water. If this shall be neglected, it may cause the product to malfunction.
- i** When installing or repairing the air conditioner, be sure to check for refrigerant leakage. Do not contact if leakage is present. It may cause product malfunction.

- ⚠** Installation and power connections shall be made by an Authorized service. Manufacturer shall not be held responsible for damages caused by operations performed by unauthorized persons.
- ⚠** Check for any damage on the product before installing it. Do not have the product installed if it is damaged.
- ⚠** Damaged products cause a risk for your safety.
- ⚠** Anyone working on the cooling circuit shall have a valid certificate issued by the competent authority, which certifies their competence to work on the refrigerant acknowledged by the industry.
- ⚠** Service work shall only be carried out as recommended by the manufacturer.
- ⚠** Maintenance and repair, which requires the support of other workers with different expertise, shall be carried out under the supervision of a person qualified in the use of flammable refrigerants.
- ⚠** The device shall be stored in a well-ventilated place suitable for the size specified for operation.
- ⚠** The devices shall be stored in such a way that there are no continuous open flames (e.g. a working gas appliance) and ignition sources (e.g. a working electric heater).
- ⚠** The device shall be stored in such a way that it cannot be mechanically damaged.

Right place for installation

- Do not place the product on an improper surface or at a point with risk of falling. This may result in death, serious injuries or damage to the product.
- Install the product on a secure and flat surface in environments with no risk of freezing.
- Ensure that the installation area shall not deteriorate in the course of time.
- Do not install the product on a location where noise from the outdoor unit and hot air may disturb or even damage the neighbours.
- Do not install the product on a location where it will be exposed to direct wind blowing from the sea (salt spray).
- The indoor unit shall not be mounted on objects, such as LCD, TV unit that may be damaged in case of water leakage.

Power connection

Plug the product in a grounded electrical installation protected by an automatic fuse conforming to the values specified in the "Technical Specifications" chart. Our company shall not be responsible for the damages that shall be incurred due to using the product without grounding according to local regulations.

- The connection must conform to national regulations.
- The fuse of the product shall be easily accessible after installation.
- Voltage and allowed automatic fuse protection are specified on the "Technical Specifications" section. If the amperage value of the automatic fuse in your household does not match the values indicated in the "Technical Specifications" chart, have an automatic fuse with proper amperage value installed by a qualified electrician.
- The specified voltage must match your mains voltage.

- Do not use extension or multi sockets in power connection. Replace the cord if it is scratched, peeled, worn or broken. Failure to comply with this instruction may cause electric shock or damage to the product.
 - Do not use a damaged power cord, plug or an outlet. Failure to comply with this instruction may cause fire or electrocution.
 - The contact clearance of the main fuse and switches shall be at least 3 mm.
 - Do not connect the grounding wire to gas pipes, lightning rod or grounding connection of a phone. Failure to comply with this instruction may cause electric shock or damage to the product.
- ⚠ Damaged power cord of the product shall be replaced by Authorized Service.
- ⚠ If the product is malfunctioning, it must not be operated without being repaired! There is a risk of electrocution!

First Use

Before using the product, make sure that the preparations are made in accordance with the instructions in the "Important safety instructions" and "Installation" sections.

Transportation of the Product

If you need to move the product to another location, contact the Authorized Service Center.

- Be careful when you are unpacking and installing the product. Otherwise, you may be seriously injured or cause damage to the product.
- The device shall be transported by at least two persons or with the a forklift. Otherwise, it may cause injuries.

4 Preparation

What to do for energy saving

- Make sure that the capacity of the air conditioner is suitable for the room you want to use. If the cooling capacity of an air conditioner is smaller than the requirement of the room, the A/C cannot provide efficient cooling and the compressor shall be kept active continuously and energy consumption will increase as a result.
- If the air conditioner has a cooling capacity greater than the room requirement, it will cool the room very quickly and turn the compressor off and on frequently. This will increase the energy consumption of your A/C. Furthermore, since the higher capacity air conditioners have a higher sound level, the noise in the room which is smaller than the air conditioning capacity will disturb you.
- The heat insulation of the room where you use the air conditioner increases your comfort and reduces your energy consumption. Therefore, it is important to insulate the heat loss-gain points of the room properly. In addition, doors and windows of the room shall be closed during the use of the A/C. If it is necessary to keep the doors open (in places such as shops and stores), devices such as air curtains that prevent the flow of hot or cold air from outside shall be used.
- The use of blinds, curtains or shades during the hours when the sun directly enters the windows prevents an increase in the energy consumption of the air conditioner.
- Where the outdoor unit is under direct sunlight, protection from direct sunlight by awning, shade, etc. (provided that the airflow of the outdoor unit is not obstructed) prevents increased energy consumption.
- It is important that the installation instructions of indoor and outdoor units during installation are observed. In particular, the air inlet and outlet vents of the units and the blowing vents shall be free of objects that may block the air flow.
- Setting the air conditioner to a temperature lower than the temperature you need will increase your energy consumption and reduce the comfort effect. You can use the air conditioner at more suitable temperatures according to your needs instead of using the lowest/highest temperature settings continuously.
- Clean the air conditioner dust trap filters at regular intervals. Clogging of the filters over time will prevent airflow thus preventing you from getting the performance you expect from the air conditioner. This will also constrain the air conditioner to increase energy consumption.
- It is very important to clean the heat exchangers in the indoor and outdoor units of the air conditioner. Contamination or clogging of the heat exchangers will cause the air conditioner to operate harder to achieve the desired cooling/heating performance, thus increasing its energy consumption. For this reason, we recommend that you have the air conditioner serviced at least once a year. (Annual maintenance is not covered by the warranty.)
- You can reduce energy consumption by using the programming feature of the air conditioner. You can turn off the air conditioner when you are not using the room and turn it on again when you will use it.
- We recommend adjusting the air direction air deflector so that it does not disturb the occupants of the room. Using the "Chaos Swing" feature will help you achieve a more even air distribution within the room.

Inserting the batteries

Open the battery compartment cover of the remote control in the direction of the arrow. Insert two AAA 1.5 V batteries into their slots, making sure the (+) and (-) directions are correct, and reattach the cover.

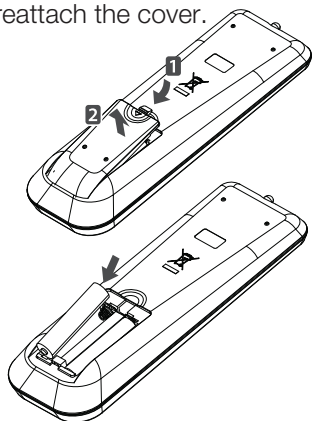

i If the display of the remote control disappears, reinstall the batteries.

Operation method

To operate the air conditioner, point the remote control towards the receiver to the right of the front panel of the air conditioner.

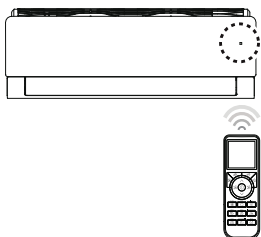

i The remote control may operate other electronic devices if pointed. Point the remote control towards the signal receiver of the air conditioner.

i For proper operating conditions, clean the signal transmitter and receiver using a soft cloth.

Points to take into consideration when using your remote control

- When using the remote control, point it towards the signal receiver on the air conditioner.
 - Make sure that there are no obstacles between the remote control and the air conditioning receiver.
 - If the air conditioner does not beep when you press the remote control buttons, that means that no signal is received. Press the button once more.
 - Don't let the remote controller fall down.
 - Do not place the remote control in a location where it will receive direct sunlight or near a device that emits heat.
- i** Do not install rechargeable batteries in the remote control whose shape, size and performance differ from standard batteries. If you do not operate the air conditioner for a long time, remove the batteries from the remote control.

5 Operating the product

Turning the A/C on

1. If the automatic fuse of the A/C is off, switch it on.
2. Direct the remote controller to the Operation status display on the indoor unit and press the "ⓘ" button on the controller. The operating status indicator display on the front panel illuminates and a warning signal comes from the air conditioner.
3. Select the desired mode using the remote control.

Operating modes

The air conditioner can be operated in 5 different operating modes.

Cooling mode (Soğutuyor)

It is used to provide cooling at desired temperature and conditions.

Heating mode (Isıtıyor)

It is used to provide heating at desired temperature and conditions.

Auto-operation mode (Otomatik /)

Depending on the set temperature, the air conditioner operates automatically in heating or cooling mode. The air conditioner is used to automatically control the fan speed and temperature by detecting the room temperature.

Dehumidifying mode (Nem Al /)

It is used to reduce humidity without the overcooling of the environment where the temperature is relatively low but the humidity is high.

Fan mode (Fan /)

It circulates the air without changing the room temperature.

Mode selection

1. Press the "Mode" button  on the remote control. Each time you press the button, the mode will change and switch to Auto Operation, Dehumidification, and Fan modes respectively. Select one of the operating modes.

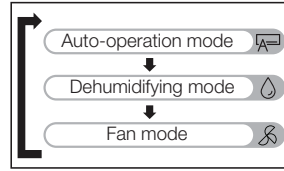

2. Use the "◇" buttons on the controller to set the room temperature and the "↻ / ⌘" button to adjust the fan speed.

Cooling of the room (Soğutuyor)

Cools the room with comfortable air current.

1. To operate the product, press the "ⓘ" button
2. Press the "Cool" button () to switch to cooling mode. "Cooling" symbol will be displayed on the screen.

Controller display

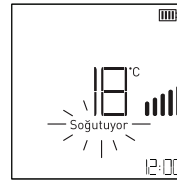

A/C indicator



3. Press the "◇" buttons until you reach the desired temperature. Each time you press the button, the set room temperature will increase or decrease by 1° C. - The temperature range is between 18° and 30° C.
4. You can change the desired fan speed. See "Fan speed adjustment"
- i** Set the temperature value on the remote control display to a value below the room temperature.
- i** If the A/C operates continuously for a long time in cooling mode, condensation may form on the front panel and the horizontal flaps.

Rapid cooling function

Allows the room to cool rapidly.

1. To operate the product, "preŝs the "ⓘ" button.

2. Press the "Cool" button (❄️) to switch to cooling mode. Press the "🔊" button to switch to rapid cooling function. The "P" symbol will be displayed on the screen.

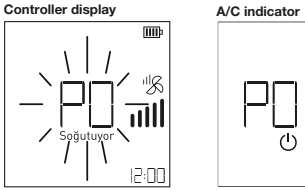

4. To cancel the rapid cooling function, simply press one of these buttons: "Fast", "Silent", "Energy Control", "🔊 / 🤫", "❄️", "Cool", "Heat" and "Mode". With the quick rapid function cancelled, the A/C will continue to operate at the highest fan speed (except silent and power-saving, 🤫 / 🔊). To change the speed, see "Fan speed adjustment"

What does rapid cooling do?

The A/C brings the temperature setting to 18°C in 30 min. at a very high fan speed while operating in cooling mode, allowing the room temperature to drop rapidly.

- ❗ Hızlı soğutma fonksiyonu özellikle sıcak yaz günlerinde oda sıcaklığını kısa sürede düşürmek için kullanılır.
- ❗ The rapid cooling function is not used in heating mode.
- ❗ This function may not be included or not work on some products.

Heating of the room (Isıtıyor)

Heats the room with comfortable air current.

1. To operate the product, press the "⏻" button.
2. Press the "heat" button (🔥) to switch to heating mode. The C symbol will be displayed on the screen.

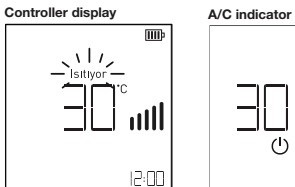

3. Press the "❄️" buttons until you reach the desired temperature. Each time you press the button, the set room temperature will increase or decrease by 1° C.
 - The temperature range is between 16° and 30° C.
4. You can change the desired fan speed as well. See "Fan speed adjustment"
 - ❗ Set the temperature value on the remote control display to a value above the room temperature.
 - ❗ When the air conditioner is in heating mode, adjust the horizontal air deflector angle to the lowest position for more efficient heating.
 - ❗ When the air conditioner is in heating mode, the indoor fan continues to operate for a while after the ambient temperature has reached the desired value. At this point, the air blown by the air conditioner may feel warm. If you feel the indoor temperature is getting lower, we recommend that you set the temperature on the controller to a higher value.

Rapid heating function

Allows the room to heat rapidly.

1. To operate the product, press the "⏻" button.
2. Press the "heat" button (🔥) to switch to heating mode. Press the "Fast" button to switch to rapid cooling function.
3. The "P" symbol will be displayed on the screen.

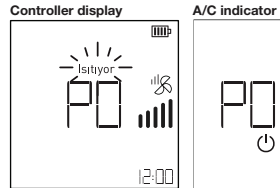

4. To cancel the rapid heating function, simply press one of these buttons: "Fast", "Silent", "🔊 / 🤫", "❄️", "Energy Control", "Cool", "Heat" and "Mode". With the quick rapid function cancelled, the A/C will continue to operate at the highest fan speed (except silent, 🤫 / 🔊). To change the speed, see "Fan speed adjustment"



What does rapid heating do?

The A/C brings the temperature setting to 30°C in 30 min. at a very high fan speed while operating in heating mode, allowing the room temperature to increase rapidly.

- i** The rapid heating function is used to quickly increase room temperature, especially on cold winter days.
- i** The rapid heating function is not used in cooling mode.
- i** This function may not be included or not work on some products.

Auto-operation mode ()

Depending on the set temperature on the controller, the air conditioner operates automatically in heating or cooling mode. The air conditioner is used to automatically control the fan speed and temperature by detecting the room temperature.

1. To operate the product, press the "⏻" button.
2. Press the "Mode" button  until the unit runs in automatic mode. The "" symbol and "Automatic" text will be displayed.

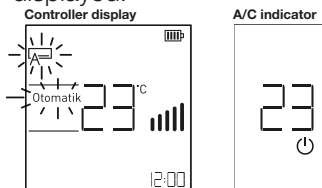

3. Press the "" buttons until you reach the desired set temperature. Each time you press the button, the set room temperature will increase or decrease by 1° C.
 - The temperature range is between 18° and 30° C. You can change the desired fan speed as well. See "Fan speed adjustment"



- i** Set the temperature value on the remote control display to a value above or below the room temperature.
- i** When the air conditioner is in heating mode, adjust the horizontal air deflector angle to the lowest position for more efficient heating.

- i** When the air conditioner is in heating mode, the indoor fan continues to operate for a while after the ambient temperature has reached the desired value. At this point, the air blown by the air conditioner may feel warm.

If you feel the indoor temperature is getting lower, we recommend that you set the temperature on the controller to a higher value.

Dehumidifying mode ()

In this mode, excess moisture is absorbed from high humidity environments and mold growth is prevented. This mode automatically adjusts the ambient temperature to keep the humidity at the optimum point during operation.

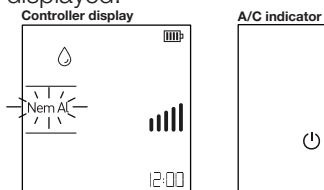

1. To operate the product, press the "⏻" button.
2. Press the "" button until the unit runs in dehumidifying mode. The "" symbol and "Dehumidifying" text will be displayed.



- i** In this mode, the air conditioner detects the room temperature and adjusts to the best condition to remove moisture based on the room temperature. The set temperature is not displayed on the remote control in this case.
- i** During the hygienic dehumidification function, it is automatically adjusted according to the algorithm that meets the current room temperature and keeps the room condition healthy and comfortable even during seasons with high humidity.
- i** The indications on the A/C display may differ.

Fan Mode ()

It circulates the air without changing the room temperature.

1. To operate the product, press the "⏻" button.
2. Press the "Mode" button until the unit runs in fan mode.  The "" symbol and "Fan" text will be displayed.

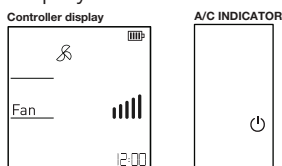

3. You can change the desired fan speed. See "Fan speed adjustment"

i In this mode, the air conditioner outdoor unit compressor does not operate.

i It sends the indoor air back to the outside environment. Circulates the air.

Fan speed adjustment

Press the "↻" and "↻" buttons to set the desired air flow rate.

Symbol	Definition
	Low fan speed
	Medium-Low fan speed
	Medium fan speed
	High-Medium fan speed
	High fan speed
	Chaos Swing (Natural air current effect)

i While in Chaos Swing mode, the fan speed automatically switches between medium or low fan speed according to the ambient temperature.

i The options may vary depending on the product function or may not work.

Temperature adjustment / Room temperature control

1. You can adjust the desired room temperature easily. Press the "▲" buttons to adjust your desired room temperature.

▲: Each time you press the button the temperature will increase by 1° C.

▼: Each time you press the button the temperature will decrease by 1° C.

Cooling mode:

If the set temperature is higher than the room temperature, the unit will not operate in cooling mode. Decrease the set temperature value.

Heating mode:

If the set temperature is lower than the room temperature, the unit will not operate in heating mode. Increase the set temperature value.

Directing the vertical air flow

1. To operate the product, press the "ⓘ" button.

2. Press Vertical (

The symbol "↑" will appear on the display and the horizontal air deflector will start to move to the set air deflector angle range.

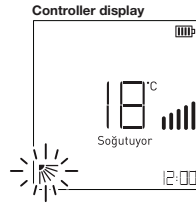

Symbol	Definition
	1. Level air deflector angle
	2. Level air deflector angle
	3. Level air deflector angle
	4. Level air deflector angle
	5. Level air deflector angle
	6. Level air deflector angle
	Free air deflector movement Horizontal air deflector moves automatically between 1. and 6. level.

i Always use the remote control to adjust the direction of the horizontal air deflector. Manual adjustment of the horizontal air deflector may damage the product.

i The horizontal air deflector will also close when the air conditioner is turned off.

i Following the free air deflector movement, pressing the "Oitel" button (

Directing The Horizontal Air Flow

Make sure the air conditioner is turned off before adjusting the vertical flaps. Carefully open out the horizontal flaps to adjust the vertical flaps. You may adjust the direction of the vertical blades by turning them right or left in 2 directions manually.

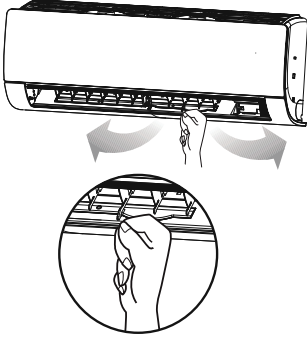

One-touch soft air (☼)

When the "☼" button is pressed, it easily adjusts the air flow at two different angles to deflect the directly incoming wind.

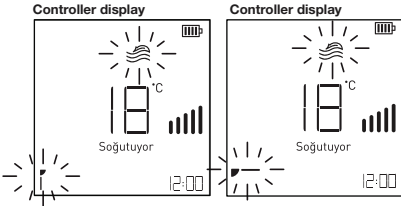

Info Display (Instantaneous Power Consumption and Ambient Temperature Display (i 3))

If the "Confirm" button (✓) is pressed and held for 3 seconds, the instantaneous energy consumption (kW) will be displayed on the indoor unit display and the actual room temperature will be displayed on the control screen.

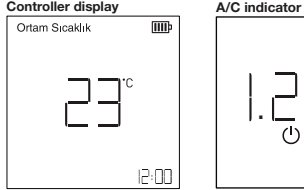

- ❗ The unit of the 1.2 value shown on the A/C display as an example, is "kW", and equivalent to 1200 Watt.
- ❗ Depending on the location of the wireless remote control in the room, the room temperature value may vary.

Display On/Off (↻)

Press "Display" button (↻) for sec. to switch the air conditioning indicator on and off.

- ❗ This function may not be supported depending on the model.

Info Display (Instantaneous Power Consumption and Ambient Temperature Display (i 3))

If the "Confirm" button (✓) is pressed and held for 3 seconds, the instantaneous energy consumption (kW) will be displayed on the indoor unit display and the actual room temperature will be displayed on the control screen.

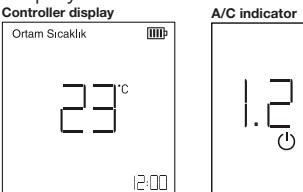

Auto clean function

(Oto Temizlik)

After the air conditioner operated in cooling and dehumidification modes, it ensures the performance of the product for a long time by drying the moisture formed in the indoor unit after the air conditioner is turned off.

1. To start the automatic cleaning function, simply press the "Temizlik" button () until the "Oto Temizlik" symbol appears on the display.

Sequencing is as shown in the table.

Controller display

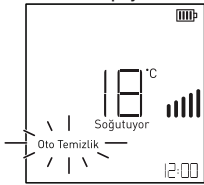

2. To cancel the function, press the "Temizlik" button () on the remote control until the "Oto Temizlik" icon goes out while the product is in operation.

i The auto-cleaning function will automatically operate for 30 minutes when you turn off the air conditioner. At this time, the horizontal air deflector of the air conditioner will be closed with a slight gap, the automatic cleaning function will be activated and the indoor fan will operate at low speed. After 30 minutes, the product will automatically switch off.

i In this position, the Co symbol will appear on the air conditioner operating status display.

i The auto cleaning function is only activated when the air conditioner is operating in cooling or dehumidifying modes.

i This function may not be included or not work on some products.



Economy ()

It saves energy during cooling process.

1. Step: In cooling mode, the power consumption is 20% lower than the rated power.

2. Step: Power consumption in cooling mode is 40% lower than rated power

3. Step: Power consumption in cooling mode is 60% lower than rated power

1. To operate the product, press the "Ⓜ" button.
2. Press the "Cool" button () to switch to cooling mode.
3. Set the A/C to a desired temperature. See "Temperature adjustment"
4. Press the "Ekonomi" button () to start 1.step thle energy-control cooling function.

Controller display

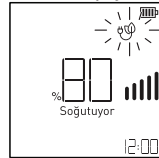

1. Step Inlet



Controller display

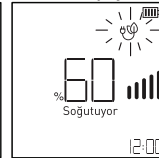

2. Step Inlet



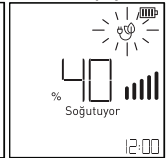

Controller display



3. Step Inlet



5. To start 2. Step the energy control cooling function press the "Ekonomi" button () again.

6. To start 3. Step the energy control cooling function press the "Ekonomi" button () again.

- i** The economy function is valid for the following temperature setting values.
Indoor Temperature 18°C (64°F) - 30°C (86°F) - Outdoor Temperature 21°C (70°F) - 32°C (90°F)
- i** This function is only active in cooling mode.
- i** The product capacity may be reduced when the Economy function is selected.
- i** If the "Sessiz" button (🔇) is pressed while the economy function is running, the economy function is switched off and the silent function is activated.

Silent Function (🔇)

It reduces the volume level of the outdoor unit in order to avoid potential noise claims from neighbours. The reduction in sound level provided by the silent function is up to 3 dB less than normal operation.

1. To operate the product, press the "⏻" button.
2. It is available under cooling, heating, auto-operation mode.
3. Press the "Sessiz" button (🔇) to start the silent function.
4. Press the "Sessiz" button (🔇) again to switch off the silent function.

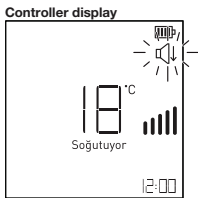

The silent function is valid between the following temperature setting values.

During cooling:

- Indoor 18°C (64°F) ~ 30°C (86°F)
Outdoor 18°C (64°F) ~ 43°C (109°F)

During heating:

- Indoor 16°C (60°F) ~ 30°C (86°F)
Outdoor 6°C (43°F) ~ 24°C (75°F)

- i** If the "Ekonomi" button (🔇) is pressed while the silent function is running, the silent function is switched off and the economy function is activated.
- i** If any other mode or any rapid function is preferred while the silent function is active, the silent function is disabled. The capacity of the product may be reduced when the silent function is selected.

Setting the clock (🕒)

1. To set the clock, press and hold the "Zamanlayıcı" button (🕒) for 3 seconds, the digits indicating the clock will flash.

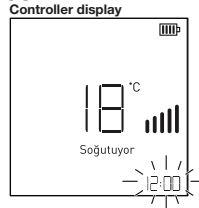

2. Set the clock using the "⬆️" buttons. (If you press the buttons for more than 3 seconds, it will change in units of 10 min.)
Press the "Onay" button (✅) to finish setting the clock. After setting is done, the clock symbol will remain fixed on the display.
3. Degrees cannot be changed until the clock setting is complete. Press the "Onay" button (✅) again to exit the clock setting function. In this case, the time when you press the "Onay" button (✅) will be saved.
4. Repeat steps 1,2,3 to change the set clock again.
- i** Clock format is 24-hour clock. It is very important to set the time correctly as the program setting you will adjust the air conditioner with will be based on the clock of the remote control.
- i** The clock can be set when the controller is off.

Sleep Function (Z)

This function prevents your room from cooling down or warming up extremely during sleep. When the sleep setting function is selected while the air conditioner is in cooling or heating mode, the unit provides optimal comfort and stops after the set time.

1. To operate the product, press the "On" button.
2. Select the desired mode by pressing one of the "Cool" (❄️), "Heat" (🔥) or "Mode" (🔄) buttons.
3. Set the A/C to a desired temperature. See "Temperature adjustment"
4. Press the "Sleep" button (Z) to start the sleep mode function.
5. Each time the "Sleep" (Z) button is pressed, the operating time of the selected mode will be added by 1 hour.
 - You can set the sleep mode between 1-7 hours.
 - If 7 hours are exceeded, the system will automatically exit "Sleep" mode.

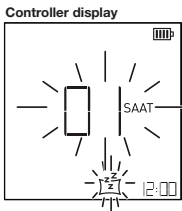

⚠️ Please select the appropriate duration for sleep mode. (Cooling your room for long periods is not good for your health.)

- ❗ While in sleep mode function, after 30 minutes, the room temperature set value will be 1° C higher than the temperature you have set in Cooling mode, and 2° C higher after 1 hour.
- ❗ While in sleep mode, after 60 minutes, the room temperature set value will be 1° C lower than the temperature you have set in Heating mode, and 2° C lower after 2 hours.
- ❗ Sleep mode can only be set while the product is operating.

Timer On/Off function

Allows the air conditioner to turn on or off automatically when you are away from home or asleep.

Timer On (Aç)

To turn on the air conditioner automatically, you can set the program by performing the following operations.

Example: Let the air conditioner switch on at 10:00 in the morning.

1. Press the "Zamanlayıcı" button (🕒) until the "Network" symbol starts to flash.

❗ Timer On, Timer Off, Cancel functions and exit from these are available as a combination under the timer button. Sequencing is as shown in the table.

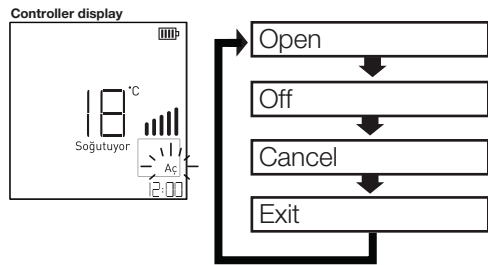

2. Set the clock using the "∧ ∨" buttons. (Each time you press the button it will change in units of 10 min.) If the button is pressed and held down for 3 seconds, the 10 minute transitions will be run faster.)

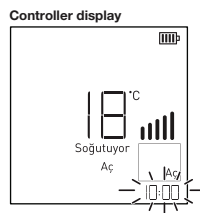

3. Press the "Onay" button (✔️) to finish setting the clock. When the setting is complete, the "Aç" symbol will appear on the remote control and the current time will be displayed.

Controller display

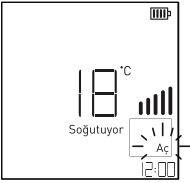

A/C indicator

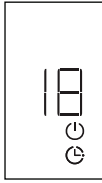

- To cancel the timer on function press the "zamanlayıcı" button (🕒) until "İptal" appears, then press the "Onay" button (✓) after exiting the "İptal" option.
- Repeat steps 1,2,3 to change the auto power on time again.

i When the Timer-On Function is set, pressing any key except the Up and Down arrow keys or the confirmation keys exits the Timer-On Function.

i Clock format is 24-hour clock. It is very important to set the time correctly as the program setting you will adjust the air conditioner with will be based on the clock of the remote control.

i The Timer-On Function is operable when the controller is off.

Timer-Off (Kapat)

To turn off the air conditioner automatically, you can set the program by performing the following operations.

Example: Let the air conditioner switch off at 10:00 in the morning.

- Press the "Zamanlayıcı" button (🕒) until the "Kapat" symbol starts to flash.

i Timer On, Timer Off, Cancel functions and exit from these are available as a combination under the timer button. Sequencing is as shown in the table.

Controller display

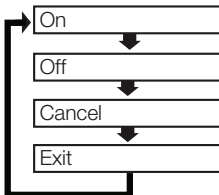
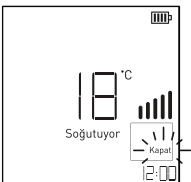

- Set the clock using the ^ v buttons. (Each time you press the button it will change in units of 10 min.) If the button is pressed and held down for 3 seconds, the 10 minute transitions will be run faster.)

Controller display

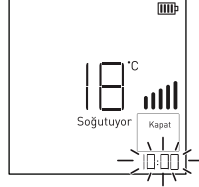

- Press the "Onay" (✓) button to finish setting the clock. When the setting is complete, the "Kapat" symbol will appear on the remote control and the current time will be displayed.

Controller display

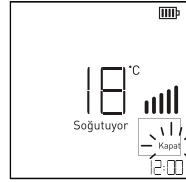

A/C indicator

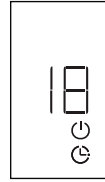

- To cancel the timer off function, press the "Zamanlayıcı" button (🕒) until "İptal" appears, then press the "Onay" button (✓) after exiting the "İptal" option.
 - Repeat steps 1,2,3 to change the auto power on time again. When the Timer-Off Function is set pressing any key except the Up and
- i** Down arrow keys or the confirmation keys exits the Timer-Off Function.

i Clock format is 24-hour clock. It is very important to set the time correctly as the program setting you will adjust the air conditioner with will be based on the clock of the remote control.

i The Timer Off Function is operable when the controller is off.

Automatic start

When the power is back following an power outage, the air conditioner starts operating using the settings before the power outage thanks to the automatic start feature. At the first start-up, the fan runs at the lowest speed and the compressor is activated after 2.5-3 minutes. The fan speed is automatically adjusted to the previous settings as soon as the compressor is activated.

Automatically start the air conditioning system

When the air conditioning system is switched on again after a power failure, this function returns the previous settings. This function is a factory default setting.

Cancel automatic restart

- 1 Open the horizontal air deflector.
- 2 Press the power button and hold for 6 seconds.
 - The device will beep twice and the light will flash 4 times.

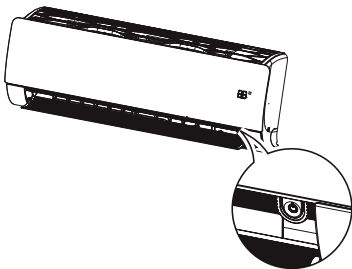

* Feature can be changed according to model type.

- To reactivate this function, press and hold the On/Off button for 6 seconds. The device will beep twice and the light will flash 4 times.

- i** If you press and hold the On/Off button for 3-5 seconds instead of 6 seconds, the unit will initiate the test operation. During testing, the unit blows out strong air current for 18 minutes for cooling and then returns to factory default settings.

Operating the A/C with the remote control

Use the On/Off button to turn on the air conditioner when there is no remote control. However, the fan speed is set to high.

- 1 Open the horizontal air deflector.
- 2 Press the on/off button.

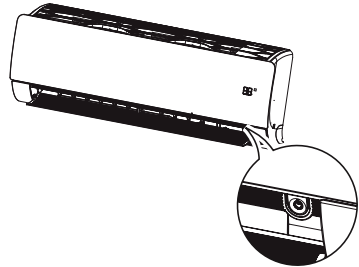

	Room temperature Above 24°C	Room temperature Between 21-24°C	Room temperature below 21°C
Operating mode	Cooling	Dehumidifying	Heating
Indoor fan speed	High	High	High
Temperature	22°C	23°C	24°C

- i** This function may not be included or not work on some products.

Test operation mode

1. For test operation mode, press and hold the manual operation button on the indoor unit for about 3 seconds. To cancel the test run mode, press the manual start button or the "ⓘ" button on the remote control.
- i** In this position, the **LO** symbol will appear on the air conditioner operating status display.
- i** The air conditioner operates for 18 minutes at maximum fan speed regardless of room temperature in cooling mode during test operation.
- i** If a signal is received from the remote control while the unit is running in test operation mode, the air conditioner will operate according to the control settings.

6 Maintenance and cleaning

Clean the product regularly to maintain optimal performance and to prevent possible malfunctions.

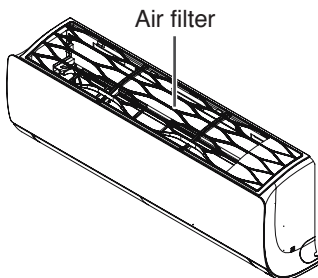

Component	Cleaning method	Cleaning interval
Air filter	See "Cleaning the air filter"	2 weeks
3M filter	See "Cleaning the 3M filter"	1 month
Indoor unit	Clean the surface of the indoor unit using a soft, dry cloth.	Periodically
	Clean the water drainage hose.	4 month
	Clean the water drainage tray where the condensation has gathered.	Once a year
	Clean the heat exchanger.	Once a year
	Replace the remote control batteries.	Once a year
Outdoor unit	Use steam to clean the heat exchanger coils and panel holes. (Consult with the authorized service)	Periodically
	Clean the fan.	Once a year
	Clean the water drainage hose.	Once a year

i The annual maintenance you will have in our Authorized Service expands the service life of the air conditioner and makes it more efficient.

⚠ Before starting cleaning or maintenance, de-energize the product.

⚠ Do not clean the air conditioner with water. There is a risk of electrocution.

- Always check for refrigerant leakage after installation or maintenance of the product.
- Use a firm stool or ladder when cleaning or maintaining the product.
- Use a soft cloth for cleaning. Do not use harsh detergents, solvents, etc.
- Install the drain hose so that it shall allow proper draining of the water.
- Do not touch the metal parts when removing the air filter. You may get injured.
- Never clean the air conditioner's ionizer filter, controller or outer surface with hot water above 40° C or with volatile substances such as thinner, acetone, benzene.

i The exterior surface of the air conditioner and the remote control may be damaged.

i At the end of the season, remove the batteries from the remote control. If you are not going to use the A/C for a long time, cover the outdoor unit of the air conditioner with a weatherproof cover.

Cleaning the air filter

The most important part of when cleaning the air conditioner is the cleaning of the air filter. If not handled carefully, the cooling-heating capacity decreases and energy consumption increases considerably. The air filter of the air conditioner shall be cleaned at the start and end of the season.

Periodically check the air filter on the front panel against clogging (at least every 15 days) depending on the contamination level of the environment of the air conditioner.

1. De-energize the device.
2. Pull the air filter slightly upwards while holding its grips.

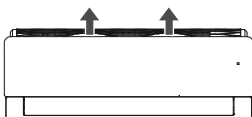

3. Remove the filter after pulling it up.

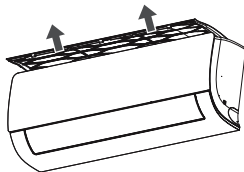

4. Clean the air filters with vacuum or warm water. If the air filter is too dirty, wash it in warm detergent water.
5. When cleaning is finished, dry in the shade and reattach the air filters.

- i** Never operate the air conditioner without air filters.
- i** Replace the air filter every 2 years.
- i** If the air filter is damaged, you can obtain a new air filter from your Authorized Service.

Cleaning the 3M filter

1. De-energize the device.
2. Remove the air filter.

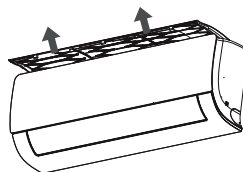

3. Pull out the 3M filter.

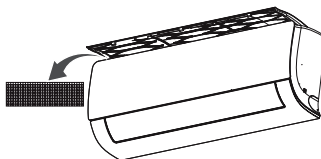

4. Remove dust and dirt from the filter with a vacuum cleaner or air. If it is contaminated, then wash with water.
5. When cleaning is finished, dry in the shade and reattach the 3M filter.

7 Recommendations for the solutions of the problems

Recommendations for the solutions of the problems

- Blown fuse or circuit breaker. >>> Check for a blown fuse or inspect the circuit breaker.
- Timer may be set incorrectly. >>> Check whether you have made a mistake while setting the timer.

Air conditioner does not cool or heat efficiently.

- Filter may be dirty. >>> Check if the filter is dirty.
- The proper temperature may not be selected. >>> Check if the temperature setting is performed correctly.
- Room may be very hot when you operate the A/C for the first time. >>> Wait a little for cooling if the room is very hot when you operate the A/C for the first time.
- Air intake to the unit from the outside may be blocked >>>> Check for any obstacle in

There is a strange smell in the room.

- Objects in the room may cause bad odour>>> Check if the odour is caused by the humidity on the walls, rugs, furniture and clothes inside the room.

The A/C runs loudly.

- i** It is not a malfunction if it sounds as if water is flowing. That is the sound of refrigerant liquid circulating inside the A/C.
- i** It is not a malfunction if it sounds like compressed air is being released.. It is the noise that occurs when the refrigerant moves to opposite directions during the heating operation inside the unit at the beginning and end of the defrosting process.

The air conditioner blows mist.

- i** If the environment is too humid, condensation will form when the air flow from the air conditioner cools the hot air. This is not a malfunction of the air conditioner and is not a failure.

The air conditioner does not start for 3 minutes when it is turned on again.

- i** This is a measure developed for the protection of the air conditioner. The AC will restart after 3 minutes.

The display of the remote control can barely be seen or can not be seen at all.

- The batteries may be depleted or incorrectly inserted. >>> Check the batteries.

When the air conditioner is turned on or off, sounds like "tick" "tick" come from the indoor unit.

- i** The temperature change causes the plastic body to shrink or expand. This is not a malfunction of the air conditioner and is not a failure.

The airflow does not start directly while heating is in progress.

- i** If the air flow starts before the temperature rises, an undesirable cooling effect will occur. To prevent this, the air flow will start after the temperature has reached a sufficiently high temperature. This is not a malfunction of the air conditioner and is not a failure.

△ If the problem persists after following the instructions in this section, contact your vendor or an Authorized Service. Never try to repair your product yourself.

8 Consumer services

Dear Customer,

Beko Call Centre is available 24/7.

From land lines or mobile phones, dial our call centre number without the area code for all your product related queries.

Calls to our call centre are charged according to the tariff designated by the mobile/land line operator. Please fill out the form on the "Consumer Services" page of our website at www.beko.com.tr or send us a fax at 0216 423 23 53 to reach our Call Centre. Our address for written applications: Arçelik Çağrı Merkezi, Arçelik A.Ş. Ankara Asfaltı Yanı, 34950 Tuzla/İSTANBUL. Up-to-date contact information of our Authorized Services may be found at www.arcelik.com.tr web site.

Beko Call Centre 444 0 888

(Please call without dialling the area code from land lines or mobile phones")

Alternative Number 0216 585 8 888

Please follow the following recommendations.

- 1 When you purchase the product, please have its Warranty approved by your Authorized Dealer.
- 2 Use your product in accordance with the principles of the manual.
- 3 Make an application to our call centre from the telephone numbers above when you have a service demand related to your product.
- 4 Ask for the "technician ID" to the technician that comes for the service.
- 5 When s/he is finished, remember to ask for a Service Receipt from your technician. This "Service Receipt" shall be of use in case of a problem with your product in later stages.
- 6 Product service life: 10 years. (The spare parts necessary for the product to function will be available for this period.)

Customer Satisfaction Policy

Arçelik A.Ş. adopts a customer oriented approach with the major principle of providing our customers excellent experience where our brand of service can conveniently communicate customer requests and comments from every channels (phone, e-mail, www.arcelik.com.tr, fax, letter, social media, service, dealer, call centre) regardless of customer's profile and all these requests and comments are gathered in a single pool of information which is traceable, reportable, transparent and reliable and all records are handled with confidentiality, objectively and fairly in line with legal regulations and assessed and the processes are continuously controlled and improved.

In parallel with our approach, all processes are integrated to management system and system which controls the other system is established. Management targets are also fed via this system.

Evaluation of the service request

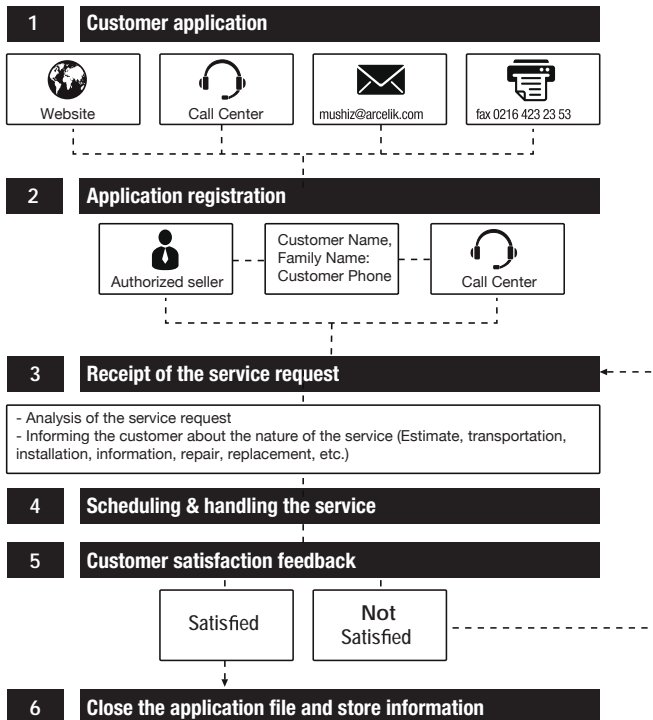

Incorrect Use and Important Notes on Warranty

Paid repair service is required for failures listed below. Warranty terms do not apply for these conditions.

- 1) Damages and malfunctions due to incorrect use,*
- 2) Damages and malfunctions occurring during the loading, unloading and handling after the product is delivered to the customer,*
- 3) Damages and malfunctions on-site caused by failures in utility services such as electricity, water, gas, phone, etc.*
- 4) Damages and malfunctions caused by acts of nature and fire, flood, etc.*
- 5) The malfunctions occurring due to the product being used against the conditions specified in the instruction and user guides.*
- 6) Damages and malfunctions arisen in case of utilization of the goods for commercial or occupational purposes with the method as prescribed in 6502 numbered law on the protection of the consumer.*

In case intervention is made for goods such as repair and maintenance or any other reason, the warranty granted for the product shall expire.

The warranty period for the product replaced during warranty application is limited to the remaining warranty period of the replaced product.

This product has been manufactured by Arçelik LG Klima San. ve Tic. A.Ş. on behalf of Arçelik A.Ş.

Warranty Certificate

Air Conditioner

WARRANTY CONDITIONS

- 1) The warranty period starts from the delivery date of the product and is 3 years (the compressor of the product is covered by a 10 year warranty).
- 2) This item and all its incorporating parts are covered under a warranty against material, workmanship and manufacturing defects for the duration of aforementioned period starting with the date of delivery provided that the item is used in accordance with the instruction and user guides and is not tampered except for service personnel authorized by Arçelik A.Ş. for repair or any reason otherwise.
- 3) If it is understood that the product is faulty, one of the rights included in article 11 of Law Regarding Protection of Consumer Number 6502 that are;
 - a- Renege on contract,
 - b- Request discount on sale price,
 - c- Request free repair,
 - d- Request the sold product to be replaced with a non-faulty one, can be invoked.
- 4) If the consumer chooses the right of free repair, the seller is obliged to perform or make repairs without charge of labour costs, replacement part costs or any other costs under any other title. The consumer may also exercise his right of free repair against the manufacturer or importer. The seller, producer and importer are jointly liable that the consumer exercises this right.
- 5) If the consumer uses the right of free repair and;
 - if the product fails again during warranty period,
 - if the maximum term necessary to repair is exceeded,
 - it is determined that repair is not possible by a report issued by authorized service station, seller, manufacturer or importer; consumer may request the refund of the product cost, a discount amounting to the fault or replacing the product with a non-faulty one, if possible. The seller may not reject the consumer's request. The seller, the producer, and the importer are jointly liable in the event that this claim is not met.
- 6) The maximum repair period of the product during its service life specified in the relevant legislation may not exceed 20 days. This period starts on the date of notification of the malfunction of the product to the authorized service station or the seller within the warranty period, and if the malfunction occurs outside of the warranty period, it starts from the delivery date of the product to the authorized service station. If malfunction of the product within the scope of the warranty can not be resolved the within 10 workdays, the manufacturer or importer is obliged to provide the consumer with another product with similar features until the repair of the product is completed. The manufacturers or importers are relieved of this obligation if the consumer does not request another product with similar featured. If the product fails within the warranty period, the time spent in repair works is added to the warranty period.
- 7) Damages or malfunctions arising from the use of the product contrary to the instructions contained in the instruction manual are not covered by the warranty.
- 8) Consumer can apply to Consumer Arbitrator Committee or Consumer Court where the consumer action is conducted in cases of disputes arising from issues regarding using the warranty rights.
- 9) If Warranty Certificate is not provided by the seller, the user may apply to Ministry of Customs and Market Surveillance Head Office.

Manufacturer's or Importer's:

Name : Arçelik A.Ş.
Address : Arçelik A.Ş. Karaağaç Caddesi
No:2-6, 34445 Sultice/İSTANBUL
Telephone : (0-216) 585 8 888
Fax : (0-216) 423 23 53
Website : www.beko.com.tr

The items;

Brand : Beko
Type : Air conditioner
Model :
Label and Serial Number:
Warranty Period: 3 YEARS
Maximum Repair Time: 20 workdays

GENERAL MANAGER



Arçelik A.Ş.

DEPUTY DIRECTOR GENERAL



Seller's:

Name:
Address:
Telephone:
Fax:
e-mail:

Invoice Date and Number:
Delivery Date and Location:
Signature of the authorized person:
Company Stamp:

This part is to be signed and stamped by the Authorized Dealer.